

WILLIAMSON-TRAVIS COUNTIES MUD NO. 1 NEIGHBORHOOD AND STREET LIGHTING MAP

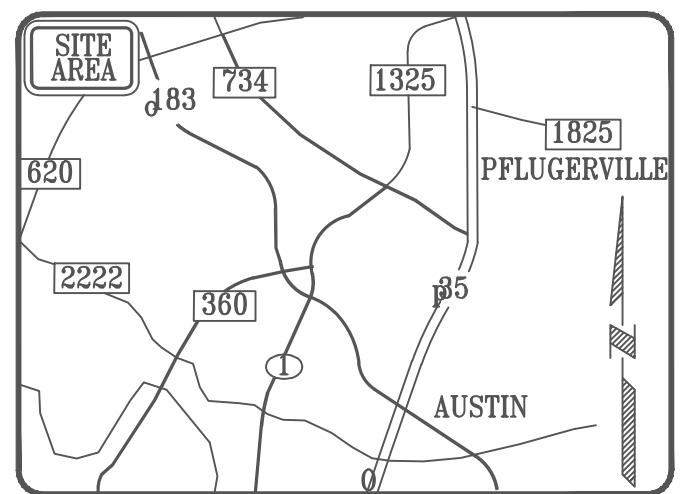

VICINITY MAP
N.T.S.

INDEX MAP
N.T.S.

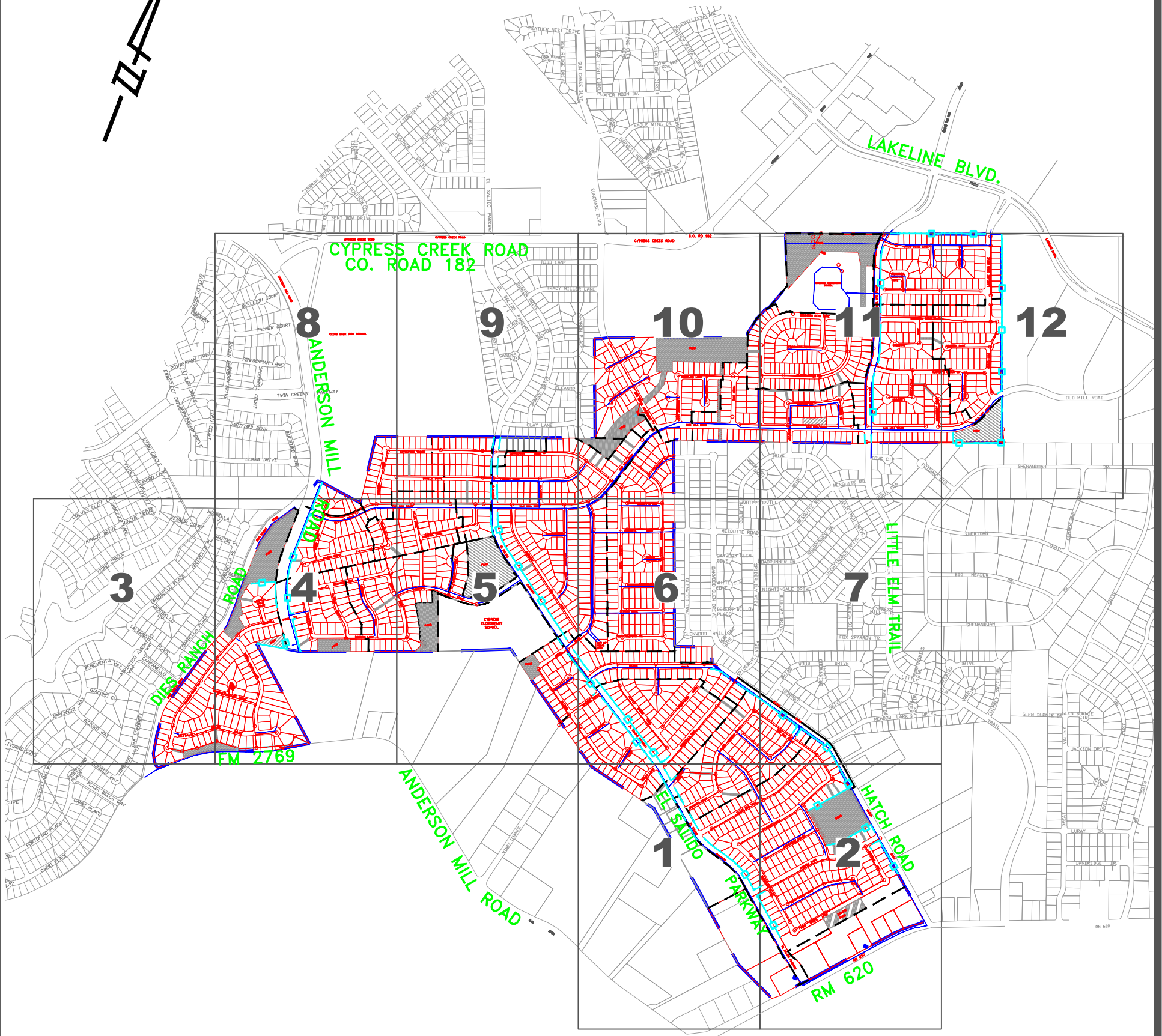
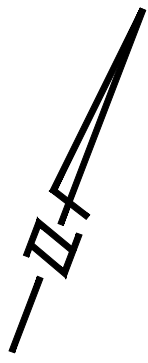

8834 N. Capital of Texas Hwy.
Austin, Texas 78759
Suite 140
(512)452-0371
FAX(512)454-9933
TBPE FIRM #2946

SEE MAP 6

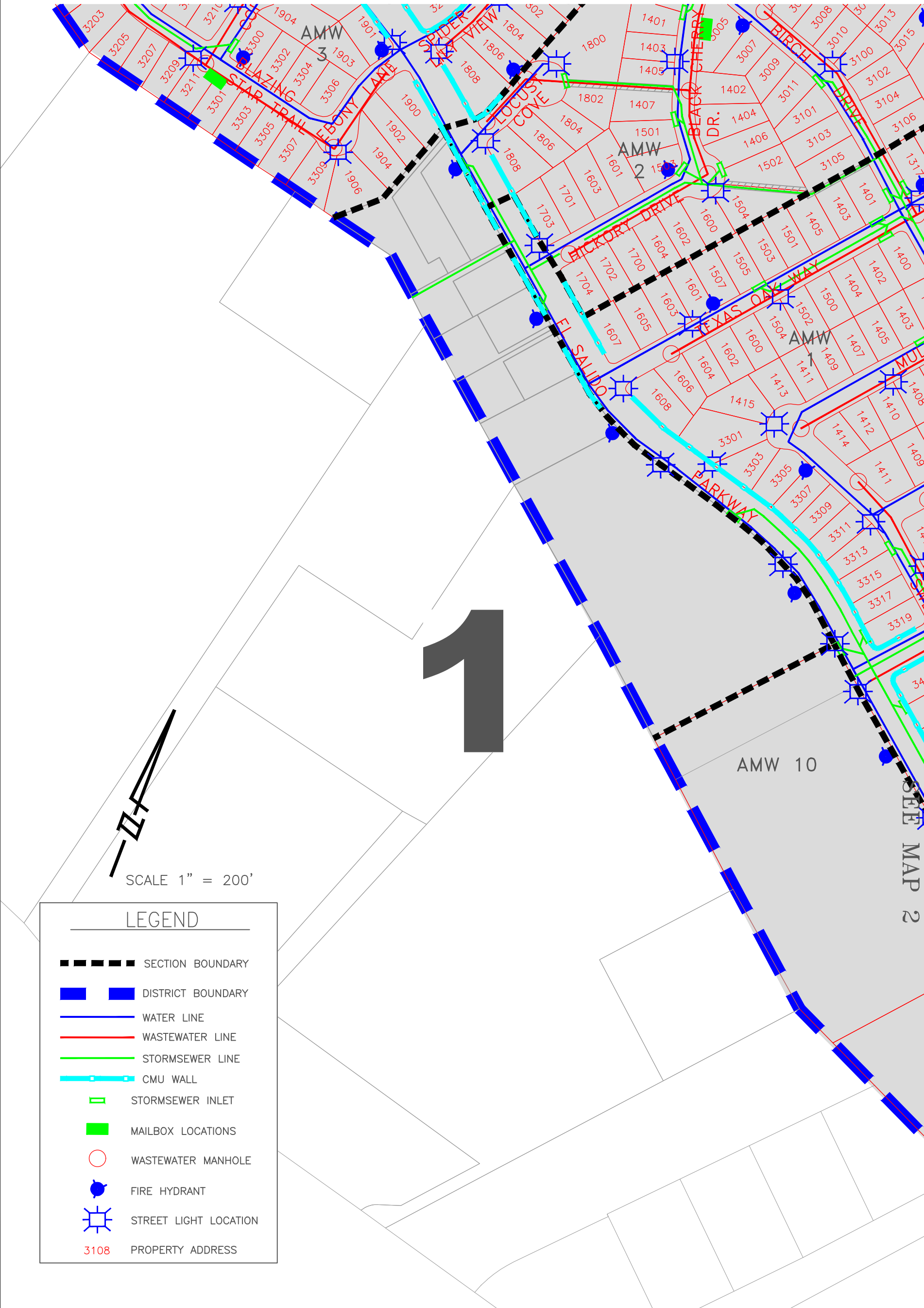

SCALE 1" = 200'

LEGEND

- SECTION BOUNDARY
- DISTRICT BOUNDARY
- WATER LINE
- WASTEWATER LINE
- STORMSEWER LINE
- CMU WALL
- STORMSEWER INLET
- MAILBOX LOCATIONS
- WASTEWATER MANHOLE
- FIRE HYDRANT
- ⊕ STREET LIGHT LOCATION
- 3108 PROPERTY ADDRESS

SEE MAP 7

2

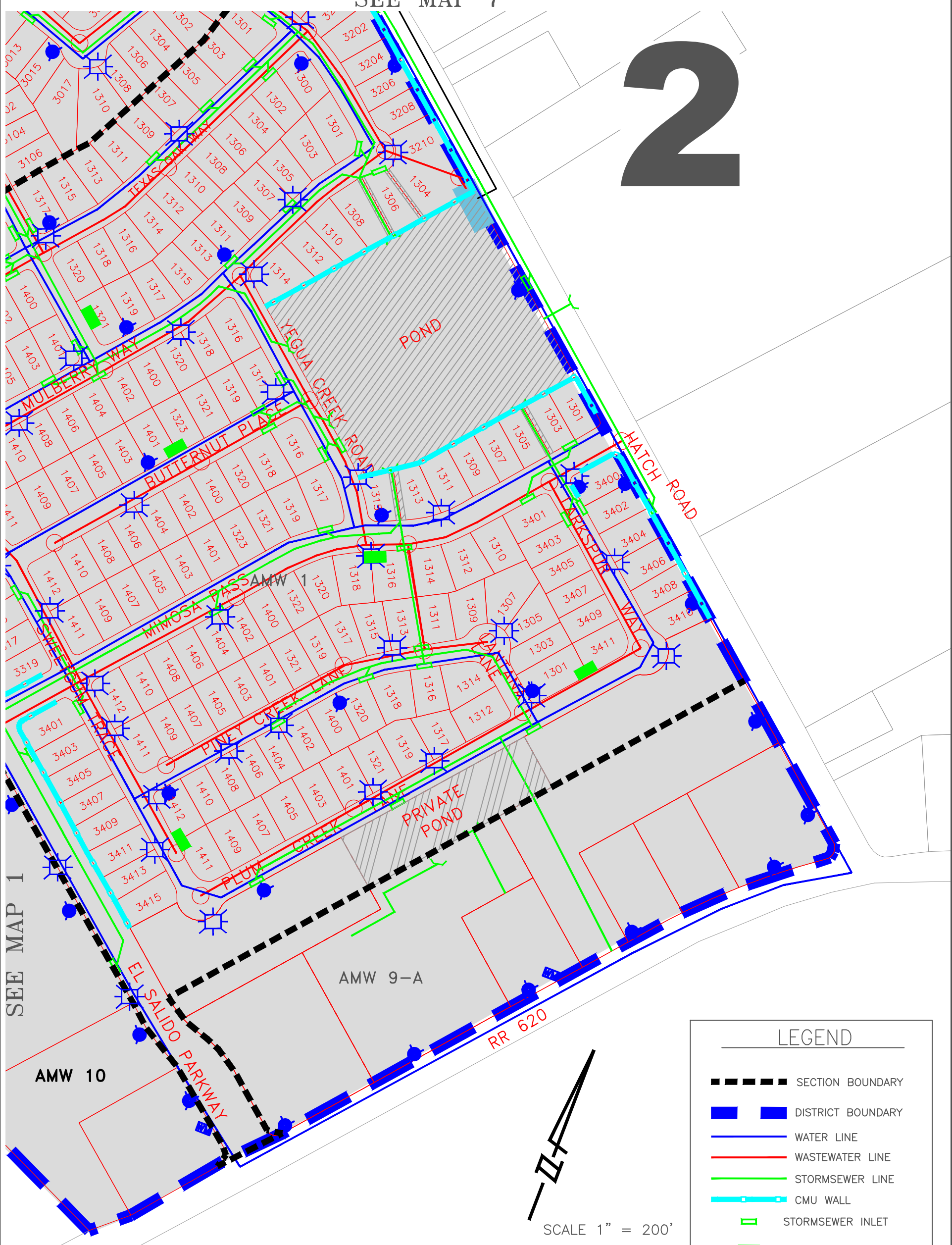

SEE MAP 1

LEGEND	
	SECTION BOUNDARY
	DISTRICT BOUNDARY
	WATER LINE
	WASTEWATER LINE
	STORMSEWER LINE
	CMU WALL
	STORMSEWER INLET
	MAILBOX LOCATIONS
	WASTEWATER MANHOLE
	FIRE HYDRANT
	STREET LIGHT LOCATION
	PROPERTY ADDRESS

SCALE 1" = 200'

3

SEE MAP 4

SCALE 1" = 200'

LEGEND

- SECTION BOUNDARY
- █ DISTRICT BOUNDARY
- WATER LINE
- WASTEWATER LINE
- STORMSEWER LINE
- CMU WALL
- STORMSEWER INLET
- █ MAILBOX LOCATIONS
- WASTEWATER MANHOLE
- FIRE HYDRANT
- ⊞ STREET LIGHT LOCATION
- 3108 PROPERTY ADDRESS

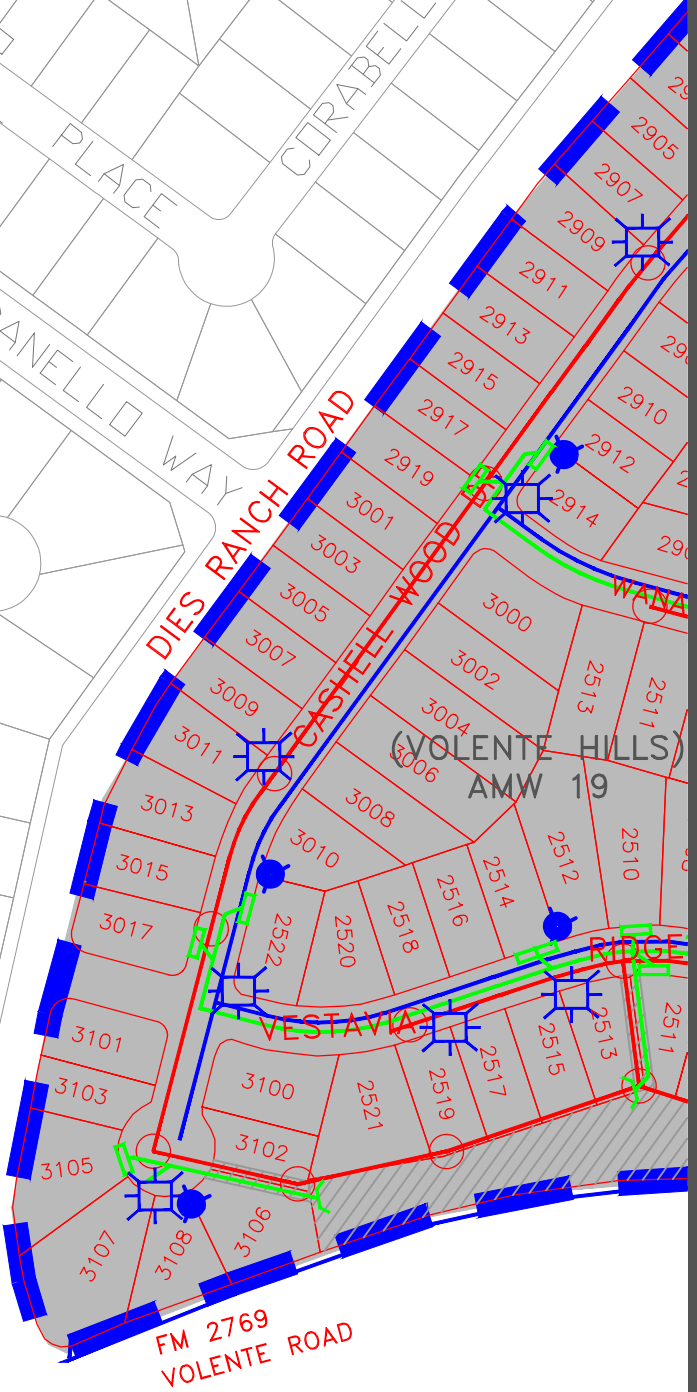

SEE MAP 8

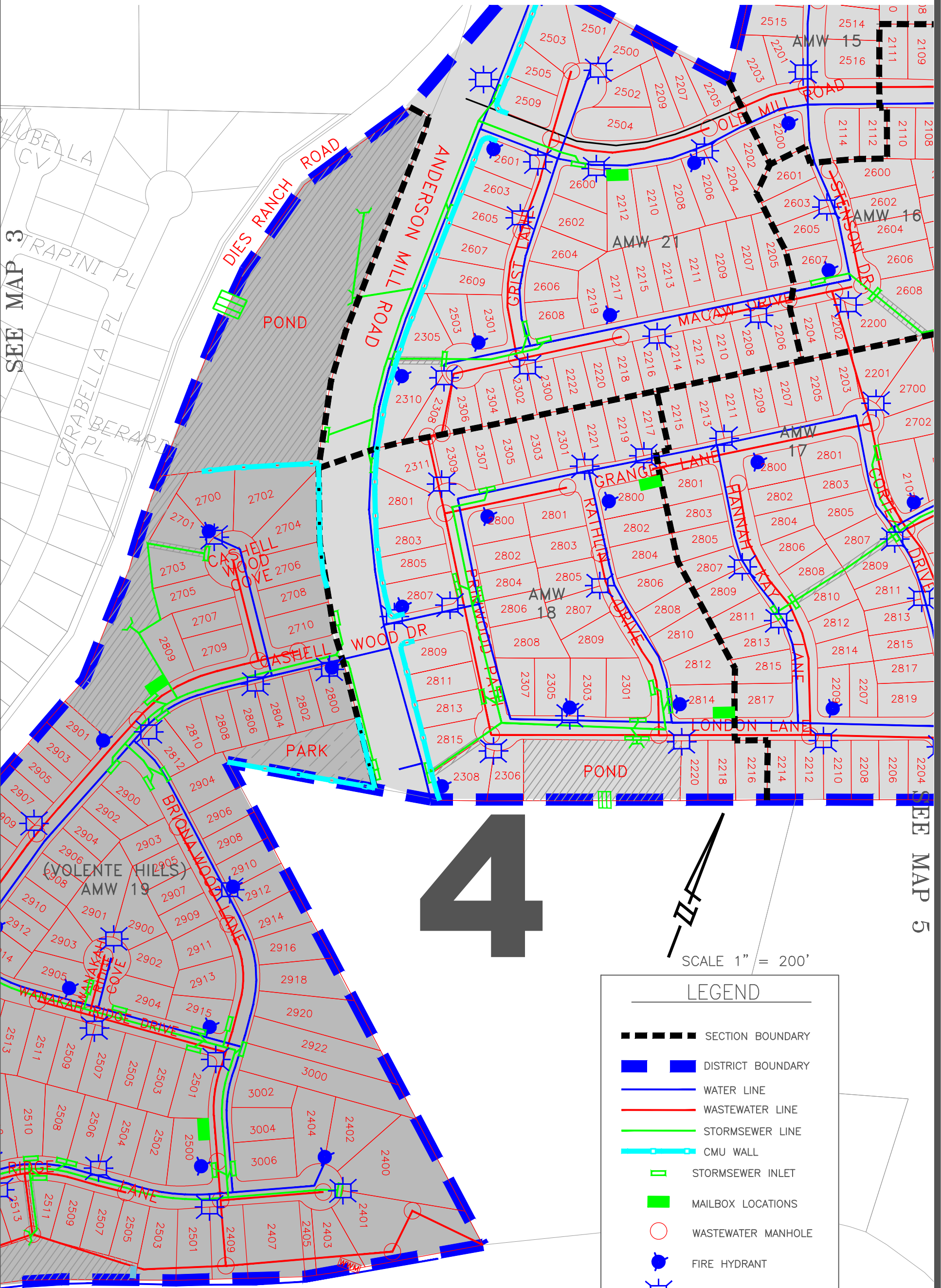

SEE MAP 3

SEE MAP 5

4

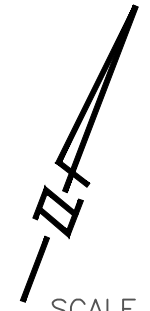

SCALE 1" = 200'

LEGEND

- SECTION BOUNDARY
- DISTRICT BOUNDARY
- WATER LINE
- WASTEWATER LINE
- STORMSEWER LINE
- CMU WALL
- STORMSEWER INLET
- MAILBOX LOCATIONS
- WASTEWATER MANHOLE
- FIRE HYDRANT
- STREET LIGHT LOCATION
- PROPERTY ADDRESS

SEE MAP 9

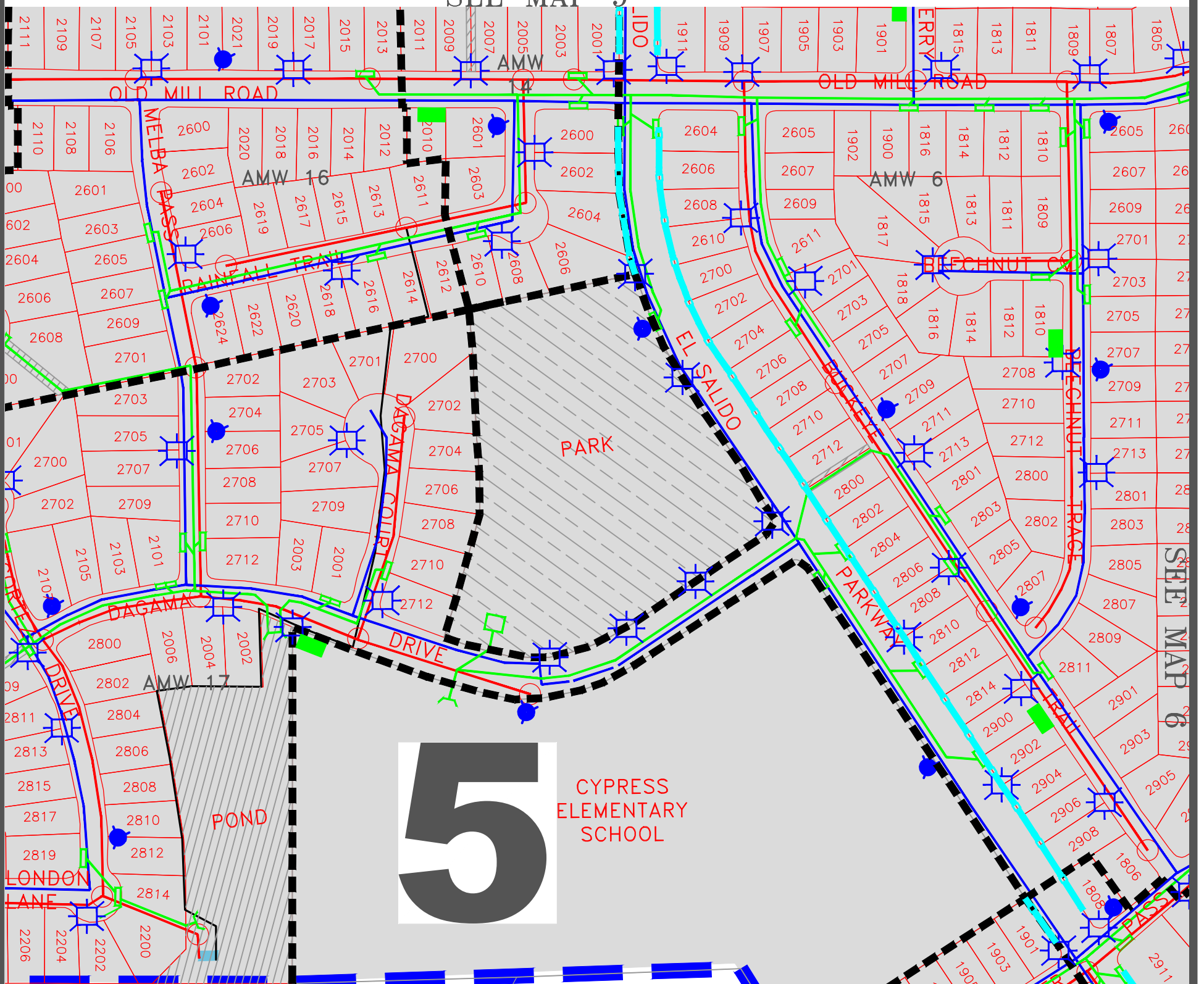

CYPRESS ELEMENTARY SCHOOL

5

SEE MAP 4

LEGEND	
	SECTION BOUNDARY
	DISTRICT BOUNDARY
	WATER LINE
	WASTEWATER LINE
	STORMSEWER LINE
	CMU WALL
	STORMSEWER INLET
	MAILBOX LOCATIONS
	WASTEWATER MANHOLE
	FIRE HYDRANT
	STREET LIGHT LOCATION
	PROPERTY ADDRESS

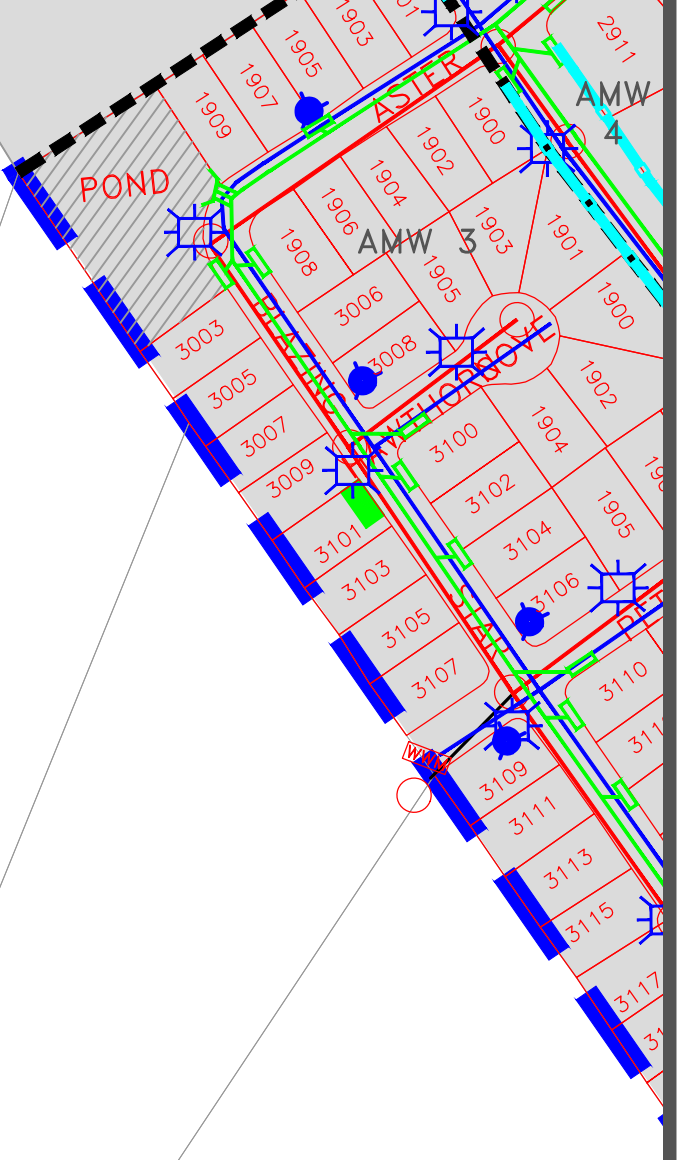
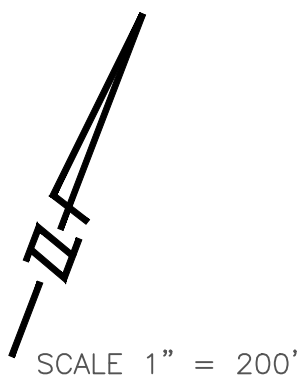

SEE MAP 6

SEE MAP 10

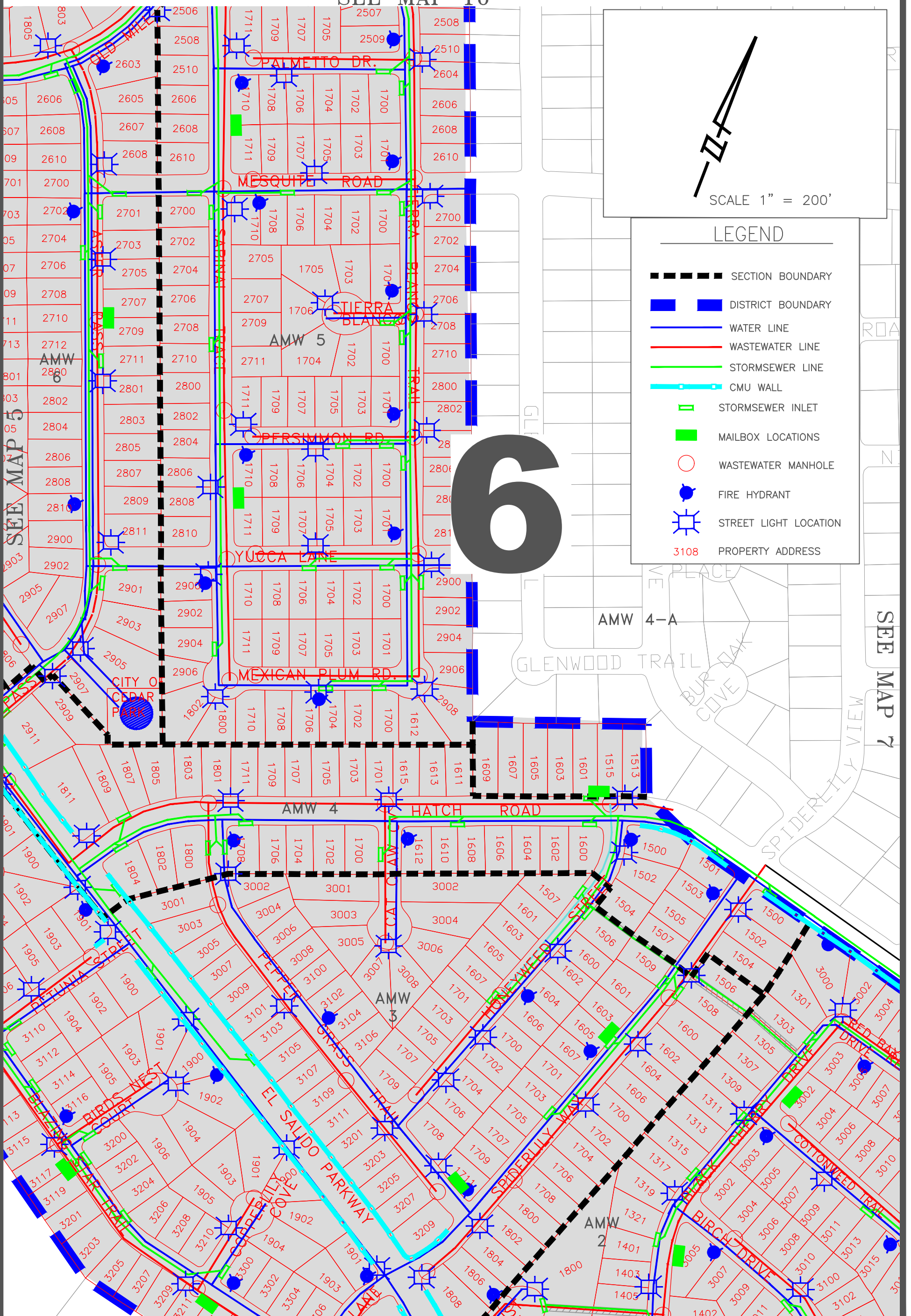

SCALE 1" = 200'

LEGEND

- SECTION BOUNDARY
- DISTRICT BOUNDARY
- WATER LINE
- WASTEWATER LINE
- STORMSEWER LINE
- CMU WALL
- STORMSEWER INLET
- MAILBOX LOCATIONS
- WASTEWATER MANHOLE
- FIRE HYDRANT
- STREET LIGHT LOCATION
- 3108 PROPERTY ADDRESS

6

SEE MAP 1

SEE MAP 5

SEE MAP 7



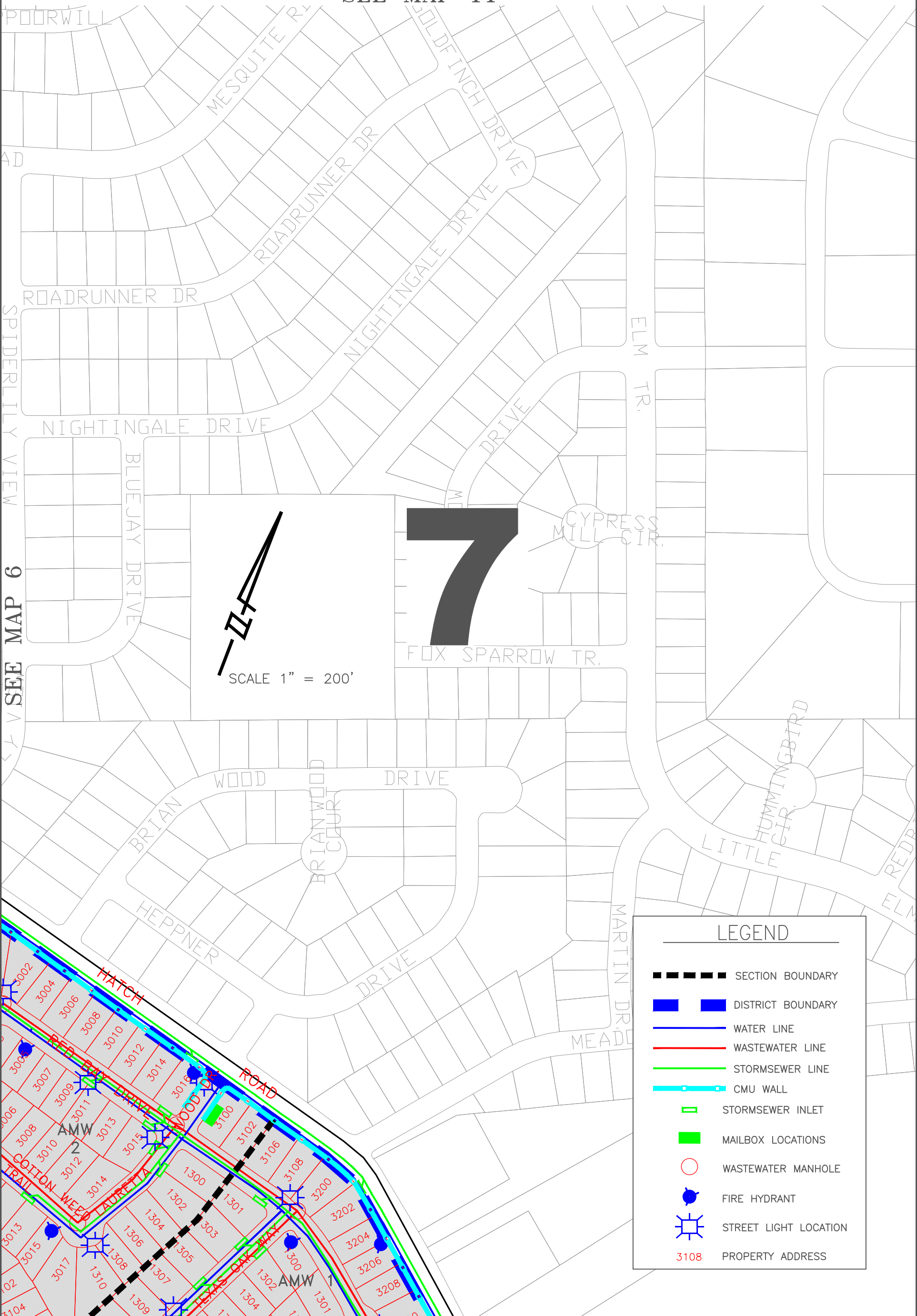



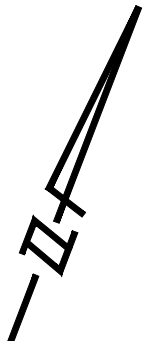





SEE MAP 11



SEE MAP 6

 SCALE 1" = 200'

LEGEND

-  SECTION BOUNDARY
-  DISTRICT BOUNDARY
-  WATER LINE
-  WASTEWATER LINE
-  STORMSEWER LINE
-  CMU WALL
-  STORMSEWER INLET
-  MAILBOX LOCATIONS
-  WASTEWATER MANHOLE
-  FIRE HYDRANT
-  STREET LIGHT LOCATION
-  PROPERTY ADDRESS

SEE MAP 2

CYPRESS CREEK ROAD

ANDERSON MILL ROAD

BEELEIGH COURT

FALMER COURT

BINDON DRIVE

POWDERHAM LANE

SPENBIL COURT

TWIN CREEKS













8

PARKWAY

CEDAR PARK HIGH SCHOOL

SEE MAP 9

LEGEND

-  SECTION BOUNDARY
-  DISTRICT BOUNDARY
-  WATER LINE
-  WASTEWATER LINE
-  STORMSEWER LINE
-  CMU WALL
-  STORMSEWER INLET
-  MAILBOX LOCATIONS
-  WASTEWATER MANHOLE
-  FIRE HYDRANT
-  STREET LIGHT LOCATION
-  3108 PROPERTY ADDRESS

SCALE 1" = 200'

SEE MAP 4

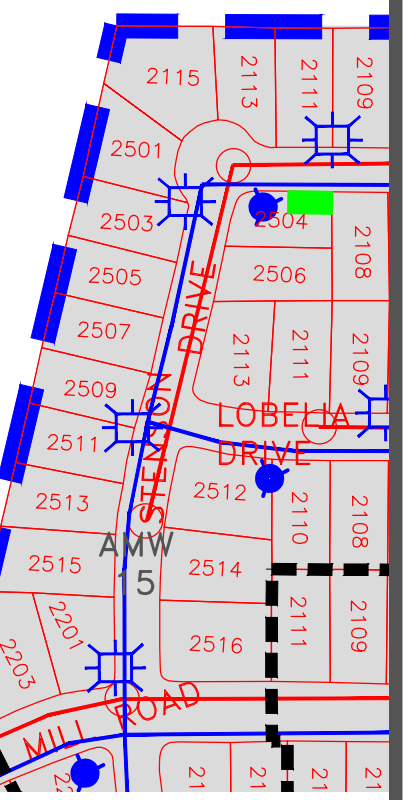

CYPRESS CREEK ROAD

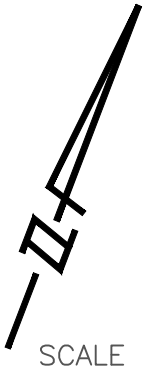

SCALE 1" = 200'

LEGEND

- SECTION BOUNDARY
- DISTRICT BOUNDARY
- WATER LINE
- WASTEWATER LINE
- STORMSEWER LINE
- CMU WALL
- STORMSEWER INLET
- MAILBOX LOCATIONS
- WASTEWATER MANHOLE
- FIRE HYDRANT
- STREET LIGHT LOCATION
- PROPERTY ADDRESS

SEE MAP 8

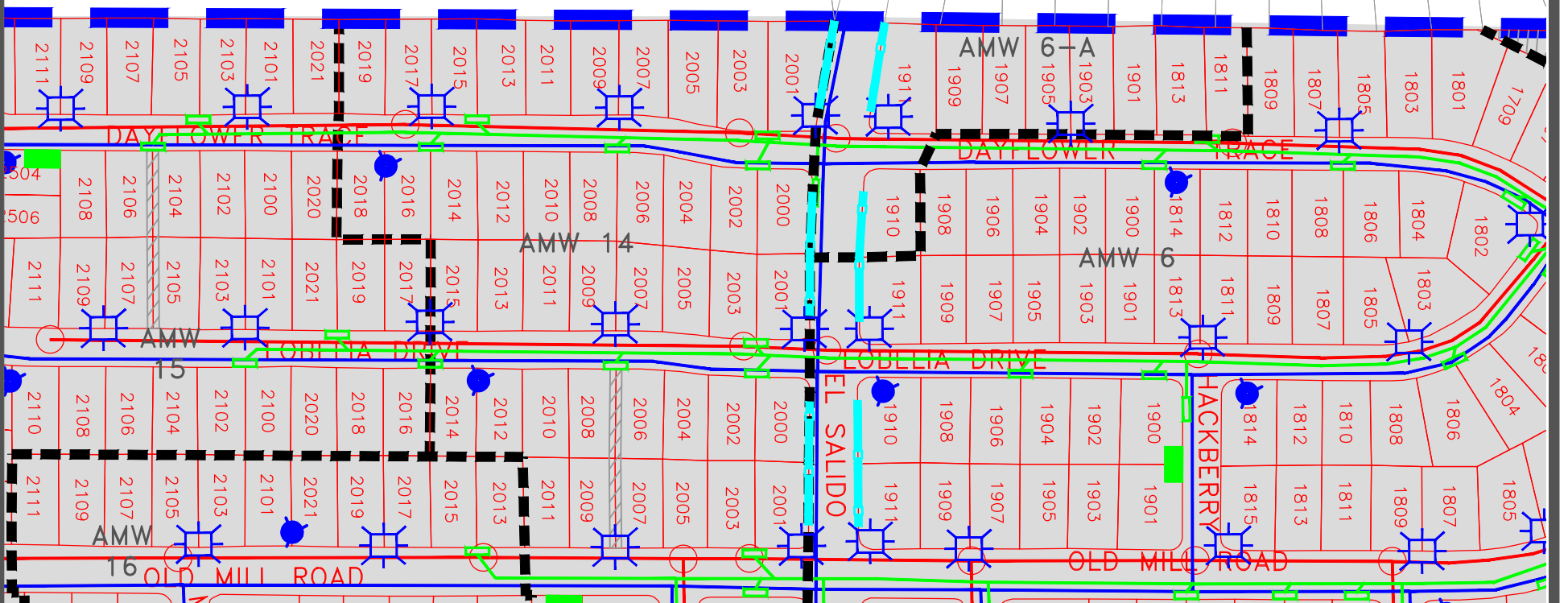

SEE MAP 10

SEE MAP 5

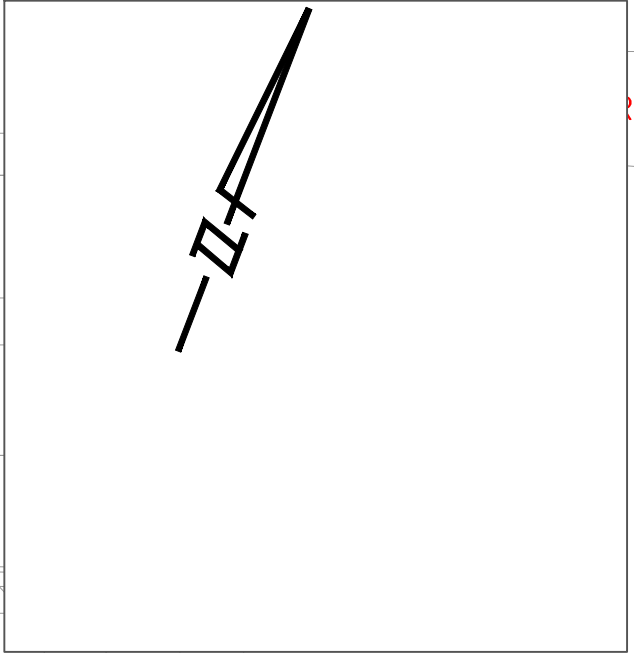

CRESS CREEK ROAD

C.O. RD 182

LEGEND

- SECTION BOUNDARY
- DISTRICT BOUNDARY
- WATER LINE
- WASTEWATER LINE
- STORMSEWER LINE
- CMU WALL
- STORMSEWER INLET
- MAILBOX LOCATIONS
- WASTEWATER MANHOLE
- FIRE HYDRANT
- STREET LIGHT LOCATION
- 3108 PROPERTY ADDRESS

10

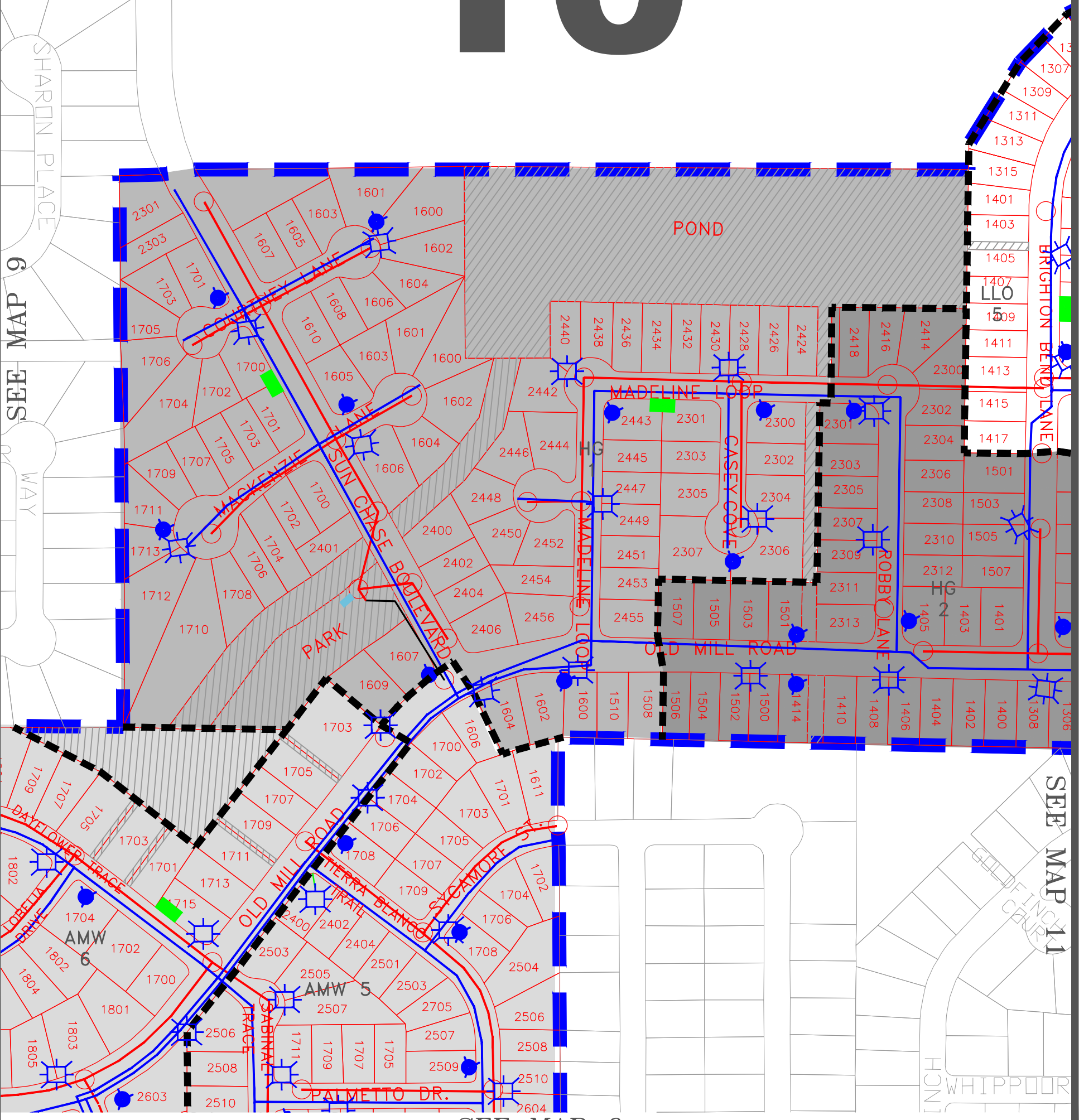

SEE MAP 9

SEE MAP 6



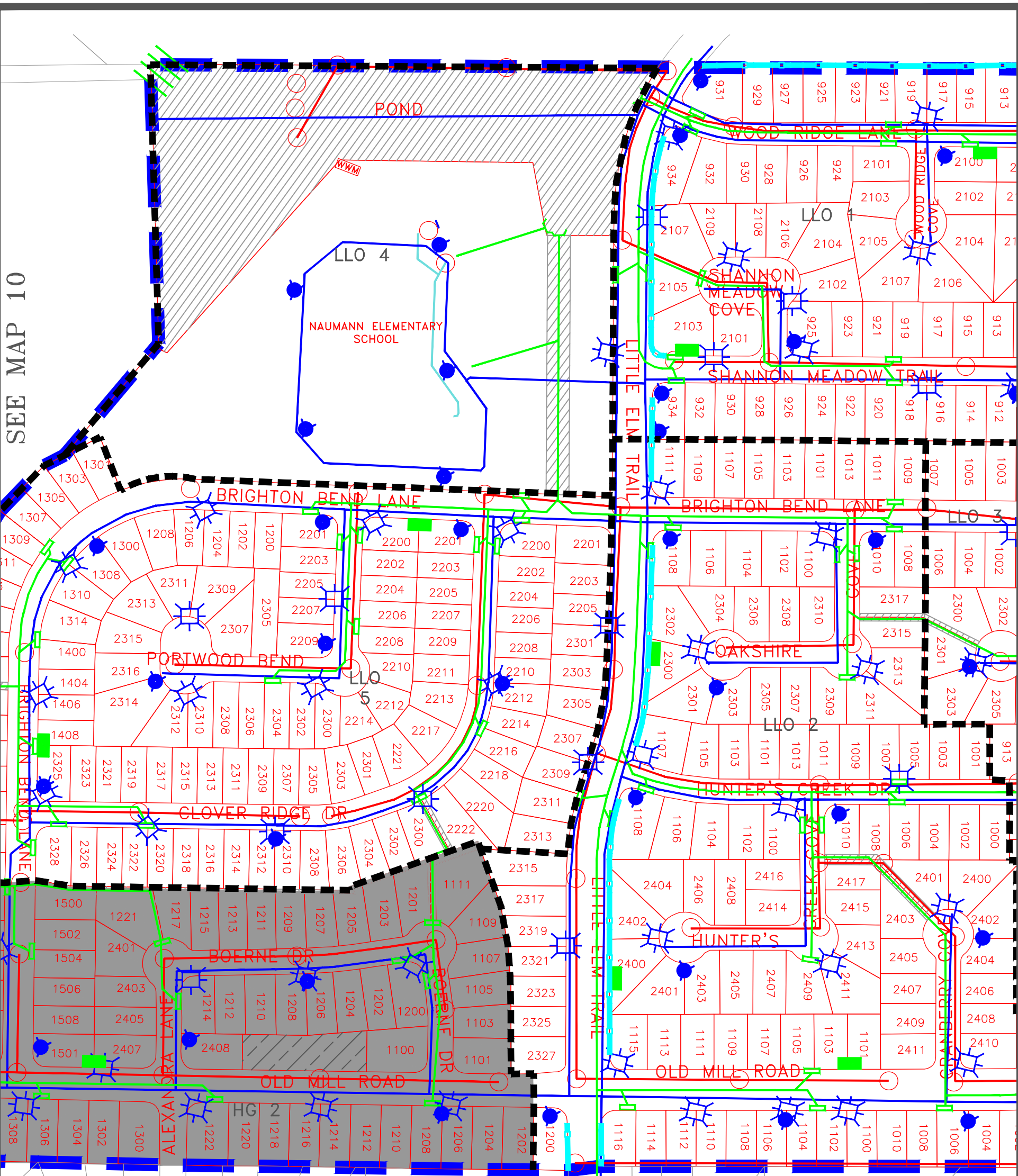









SEE MAP 11



SEE MAP 10

SEE MAP 12

LEGEND

-  SECTION BOUNDARY
-  DISTRICT BOUNDARY
-  WATER LINE
-  WASTEWATER LINE
-  STORMSEWER LINE
-  CMU WALL
-  STORMSEWER INLET
-  MAILBOX LOCATIONS
-  WASTEWATER MANHOLE
-  FIRE HYDRANT
-  STREET LIGHT LOCATION
-  3108 PROPERTY ADDRESS

11

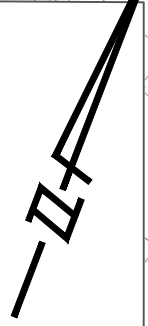

SCALE 1" = 200'

12

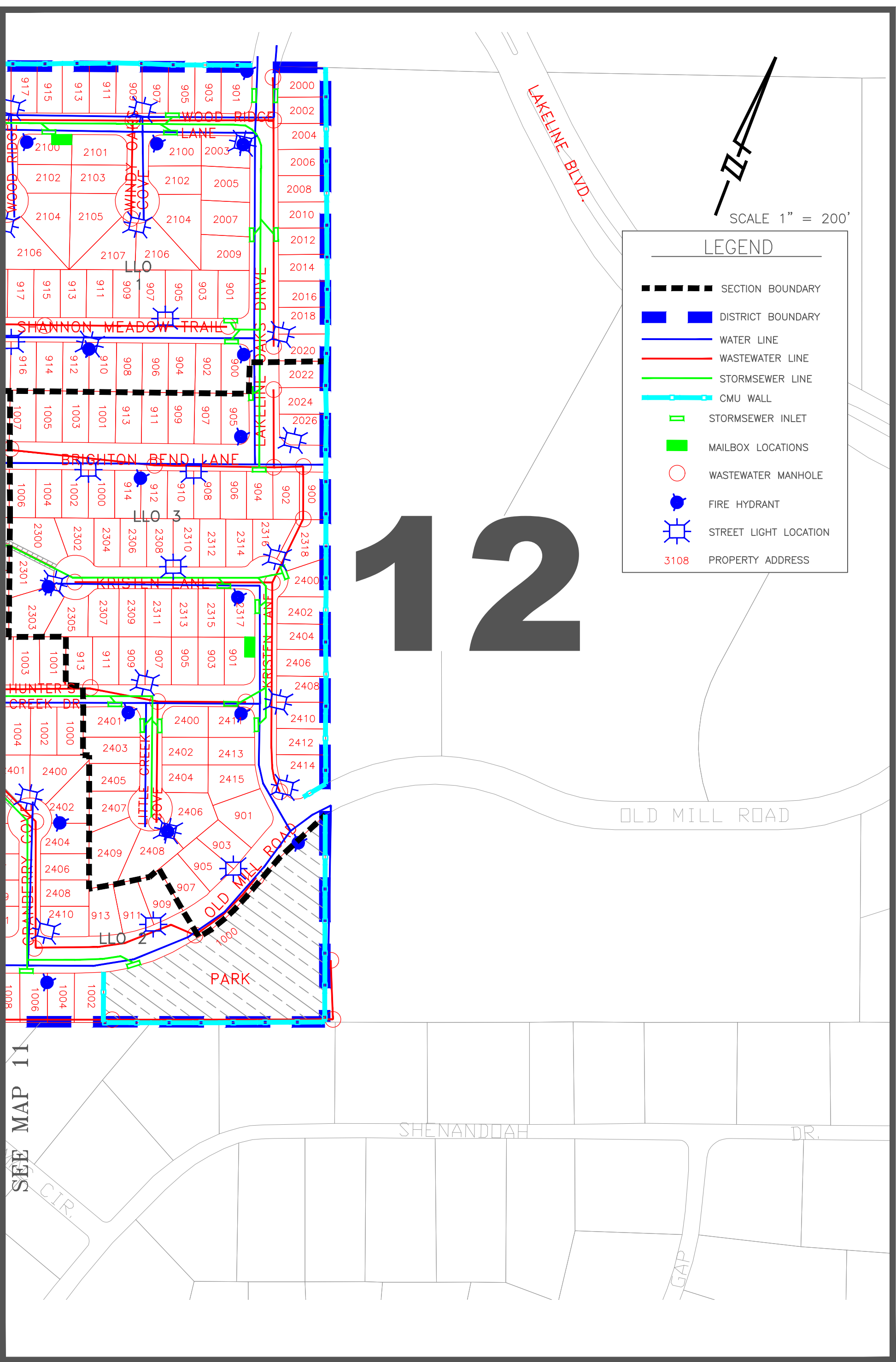

SCALE 1" = 200'

LEGEND

- SECTION BOUNDARY
- DISTRICT BOUNDARY
- WATER LINE
- WASTEWATER LINE
- STORMSEWER LINE
- CMU WALL
- STORMSEWER INLET
- MAILBOX LOCATIONS
- WASTEWATER MANHOLE
- FIRE HYDRANT
- ★ STREET LIGHT LOCATION
- 3108 PROPERTY ADDRESS

SEE MAP 11

CIR.

SHENANDOAH DR.

GAP

OLD MILL ROAD

PARK

LLO 2

JAQUA

ENV NESTOR

LLO 3

LLO 1